

Order Code	TCK-072
Inductance (each winding)	156 μ H \pm 35% (at 100 kHz / 100 mV)
Impedance (DCR)	15 m Ω max.
Rated Current	11.3 A max.
Rated Voltage	500 VDC max. (between windings)
Operating Temperature	-40°C to +105°C
RoHS Exemptions	No Exemptions

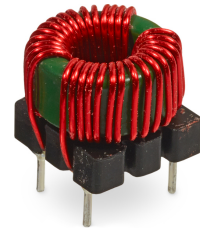

Impedance Curve

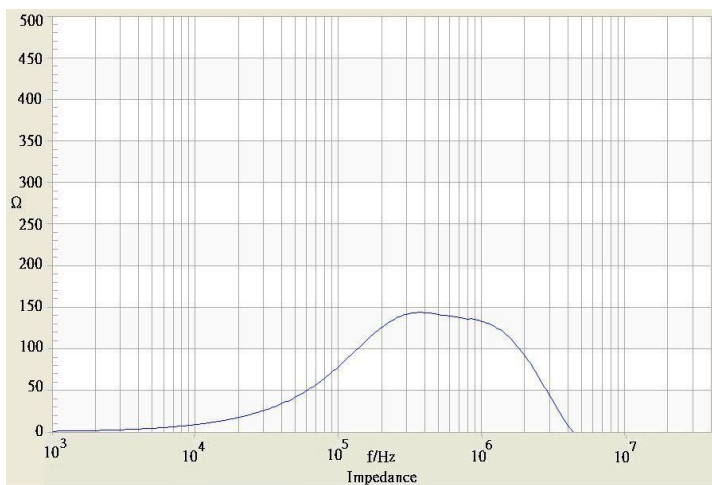

Outline Dimensions

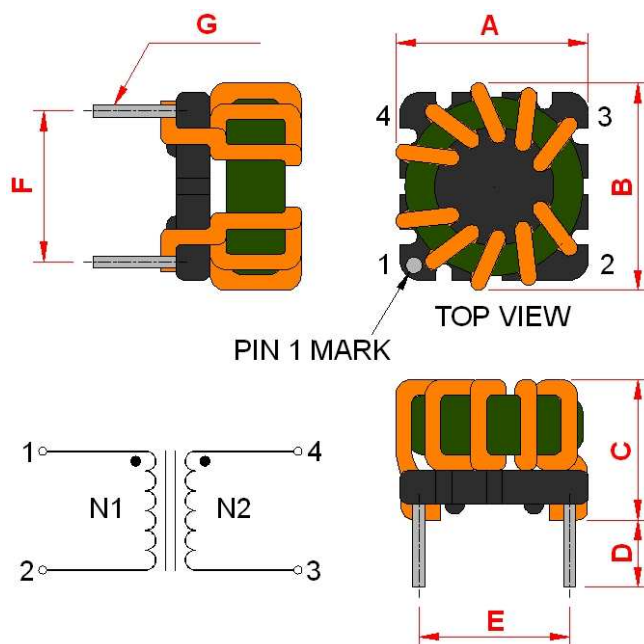

Dimensions [mm]	
A	16.0 max.
B	16.0 max.
C	15.0 max.
D	4.0 \pm 0.3
E	10.0 \pm 0.3
F	7.4 \pm 0.3
G	\varnothing 0.8

All specifications valid at +25°C, unless otherwise stated.